

CommandShot Megapixel USB 2.0 CMOS Cameras

Sumix Corporation designs and manufactures CommandShot cameras - megapixel CMOS cameras with USB 2.0 interface suitable for machine vision and microscopy applications. The cameras are designed for capturing, streaming and storing high quality digital images. CommandShot cameras benefit:

- High speed
- Communication interface: USB2.0
- External trigger
- No external power supply required
- Compact size
- Ease of use

CommandShot cameras are presented in the following models: SMX-150M, SMX-155M, SMX-160M, SMX-160C, SMX-M71M, SMX-M72, SMX-M73, SMX-M81M, SMX-M82C, SMX-M83C.

CommandShot camera kit contains: camera, tripod adapter, USB cable, trigger connector (optional), Camera Application Software and API Library.

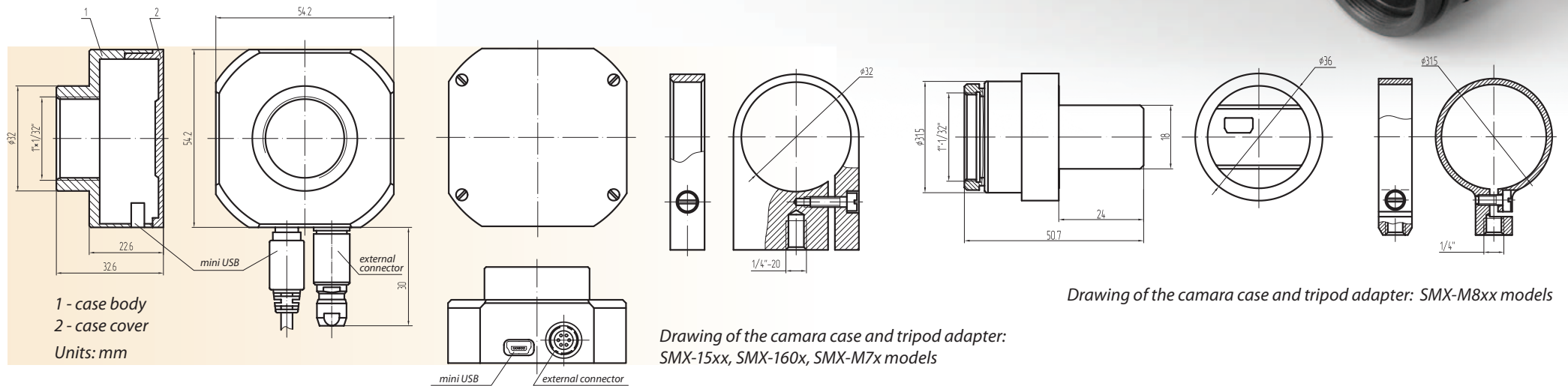





Application Software and SDK

The CommandShot cameras go with application software program and Software Developers Kit (SDK).

CommandShot camera application program provides control of various set-up commands demonstrating cameras performance. SDK contains drivers, Application Programming Interface, source code examples and documentation. CommandShot SDK provides full control of all camera functions and enables easy integration of the camera into the customers' own applications.

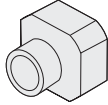
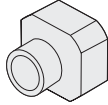
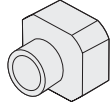
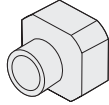
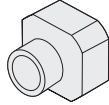
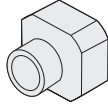
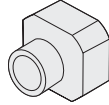
System Requirements: Windows XP (SP1) or higher, Linux (upcoming), QNX (SMX-155M only). Supported API languages: C/C++, Visual Basic, Delphi. ActiveX Component (SMX-150M only). Drivers: WDM compatible, Direct Show compatible (not available with SMX-160, SMX-155M and SMX-M8xx), Twain included (not available with SMX-160, SMX-155M and SMX-M8xx).

Comparison Chart

	SMX-150M	SMX-155M	SMX-M71M	SMX-M72	SMX-M73	SMX-160M	SMX-160C	SMX-M81M	SMX-M82C	SMX0M83C
										
Sensor type:	1.3 Mpixel CMOS	1.3 Mpixel CMOS	1.3 Mpixel CMOS	2 Mpixel CMOS	3 Mpixel CMOS	6.6 Mpixel CMOS	6.6 Mpixel CMOS	1.3 Mpixel CMOS	2 Mpixel CMOS	3 Mpixel CMOS
Image array size:	2/3 "	2/3 "	1/2 "	1/2 "	1/2 "	1 "	1 "	1/2 "	1/2 "	1/2 "
Active pixels:	1280 X 1024	1280 X 1024	1280 X 1024	1600 X 1200	2048 X 1536	2208 X 3000	2208 X 3000	1280 X 1024	1600 X 1200	2048 X 1536
Pixel size, μm:	6.7 X 6.7	6.7 X 6.7	5.2 X 5.2	4.2 X 4.2	3.2 X 3.2	3.5 X 3.5	3.5 X 3.5	5.2 X 5.2	4.2 X 4.2	3.2 X 3.2
Max. fps*:	27.5 (40MHz)	27.5 (40MHz)	30 (48MHz)	20 (48MHz)	12 (48MHz)	6 (48MHz)	6 (48MHz)	15 (24MHz)	10 (24MHz)	6 (24MHz)
Shutter type:	Global & Rolling	Global & Rolling	Rolling	Rolling	Rolling, Global Reset	Rolling	Rolling	Rolling	Rolling	Rolling (Optional Global Reset)
Color/Mono:	Mono	Mono	Mono	Color	Color	Mono	Color	Mono	Color	Color
Bit depth:	8/10	8/10	8/10	8/10	8/10	8/10	8/10	8/10	8/10	8/10
Trigger:	+	+	+	+	+	-	-	Optional	Optional	Optional
Lens mount:	C	C	C	C	C	C	C	C/CS	C/CS	C/CS
Dynamic range, dB:	64 (optical)	64 (optical)	61	61	61	61	61	61	61	61
Maximum Power Consumption, W:	1.8	1.6	2.28	2.28	2.28	2.28	2.28	0.8	0.8	0.8
Weight, g:	108	108	108	108	108	108	108	55	55	55
Dimensions, mm:	w=54.2 l=54.2 h=32.6	w=54.2 l=54.2 h=32.6	w=54.2 l=54.2 h=32.6	w=54.2 l=54.2 h=32.6	w=54.2 l=54.2 h=32.6	w=54.2 l=54.2 h=32.6	w=54.2 l=54.2 h=32.6	w=54.2 l=54.2 h=32.6 d=31.5	w=54.2 l=54.2 h=32.6 d=31.5	w=54.2 l=54.2 h=32.6 d=31.5
Win2000, WinXP:	+	+	+	+	+	+	+	+	+	+
QNX:	-	+	-	-	-	-	-	-	-	-
ActiveX Component:	+	-	-	-	-	-	-	-	-	-
WDM Compatible:	+	-	+	+	+	-	-	-	-	-
DirectShow compatible:	+	-	+	+	+	-	-	-	-	-
Twain included:	+	-	+	+	+	-	-	-	-	-

* at the highest resolution